

Schwing Line Pumps

LP 350 / SPL 1000 / SPI 1200 / SPI 1200 / SPL 1400 / SPL 1800



LP 350 / SPL 1000 / SPI 1200/ SPI 1200 / SPL 1400 / SPL 1800

The SCHWING Line Pump is a compact truck mounted concrete pump for applications where concrete should be pumped through static pipe lines. Designed for long horizontal and vertical pumping distances, this efficient pump unit meets the demands of a thoroughly rewarding niche market, i.e. in applications where the deployment time has been too short and the set up time too long for stationary concrete pumps or where standard truck mounted concrete pumps with placing booms are too large or too small.

Mobility is the crucial factor here, and is the one making this machine a valuable addition to any concrete pump fleet owned by a pump service enterprise. But more than that, it's favourable size makes the SCHWING Line Pump the ideal business launching model. The entrepreneur who has to think in economic terms when ordering his 'very first', but not at the expense of operation dependability and SCHWING quality, will find decision making simplified with the line pumps modular system. Just the basic pump unit mounted on a reasonably priced, medium sized carrier vehicle and driven by its engine provides a complete all round machine which soon gives value for money and yields a profit. The concrete pump can be retrofitted and expanded at any time to meet individual requirements.

A wide range of equipment and accessories are available for this purpose, i.e. :-

The Separate Engine

This makes the concrete pump independent of a motorized carrier vehicle and offers full capacity utilization even with second hand chassis.

The Valve Options

You choose between 1. Rock valve and 2. Flat gate valve system.

Line Pump - Special Features

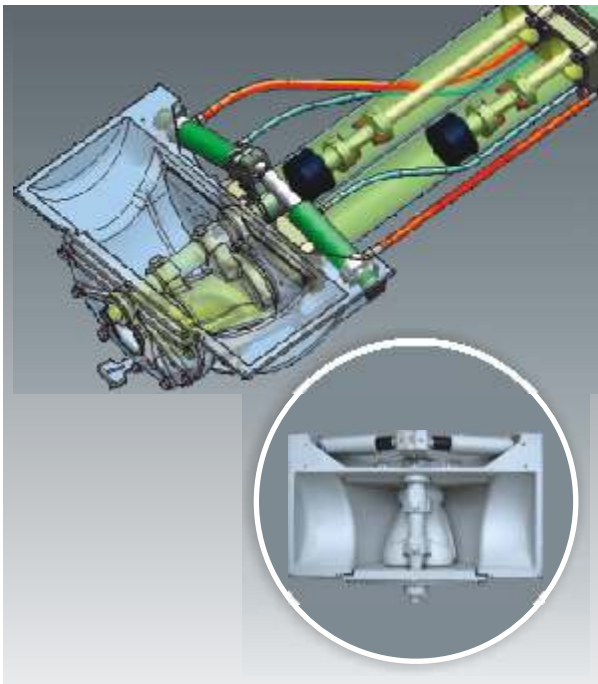

R.L Rock Valve

RL-Rock valve, engineered by SCHWING R&D after extensive studies of behavior of tough concrete in various developing countries. This rugged, reliable rock valve is highly suited for stiff, difficult mixes of concrete and ideal for use in combination with the long stroke pumping unit. An option that can be recommended is the hard facing layer for extremely long service life.

Flat gate valve

The two flat gate valves working independently have been especially developed for pumping concrete. Their working system with automatic adjustment permits trouble-free pumping even with badly worn parts.



Integrated Control Block

The hydraulic control system is integrated with in the drive. The compact control block & minimal hydraulic lines makes the equipment Reliable & durable.



Fast switching valve

Compact design individual switching circuit ensures quick operation of rock valve.





Maintenance

A central bank of grease nipples supplies grease to all of the lube points on agitator and rock valve.



Remote control

The Concrete pump comes complete with a 10 meter cable remote control as a standard feature.



Hydraulics

Direct high torque driven on to the agitator shaft as well as a robust design of all hydraulic components in conjunction with constant flow micro filtering of the hydraulic oil ensure operational reliability and a long service life.



Optional pipe rack







We recommend the selection of optional pipe rack. Using this setup you can carry 40 meters of pipeline in the truck itself safely without damage.

Line Pumps - Technical Data

Description	Units	LP 350 D	SPL 1000	LP 1400 D	LP 1800
Motor/ Engine rating	kW	49	37	D49	74
Pumping cylinder	mm	180 / 1200	180 x 1000	180 * 1400	200 * 1600
Diff-cylinder * stroke	mm	100/55*1200	90 / 50 x 1000	100/60*1400	120/80*1600
Max strokes / min		25	15	24	24
Max theor.concrete output	cu.m	46	24	52	73
Max concrete pressure	bars	60	60	99	108
Weight	kg	3100	5500	3600	4000
Max delivery line	mm	150	150	150	150
Feeding hopper capacity	liter	600	400	600	600

SCHWING - STETTER ALWAYS CLOSE TO THE CUSTOMER.



-  Branch
-  Resident Engineer
-  Resident Engineer with spares
-  Service Centres
-  Dealership Support
-  Customer Training Centers



SCHWING STETTER (INDIA) PVT LTD

An ISO 9001 : 2008 Company

CORPORATE OFFICE : F 71 - 72,
SIPCOT Industrial Park, Irungattukottai,
Sriperumpudur Taluk, Kancheepuram District,
Tamilnadu - 602105.
Phone : 044 2715 6780 / 781, 47108100
Fax : 044 27156539 Email : schwing@vsnl.com,
chennai@schwingstetterindia.com

HYDERABAD : House No. 8-3-231/W/30/A,
Plot No 30 A, Womens Coperative Housing Society,
Road No 2, Jubilee Hills, Hyderabad - 500 033.
Phone : 040 6615 1783 / 08418 305000/5 / 33555588
Fax : 040 2354 1782.
Email : hyderabad@schwingstetterindia.com

COCHIN : No.34 / 1404 B,
Edappally - Arakkakadavu Road, Anchumana,
Edappally - PO. Cochin - 682 024. Kerala
Phone : 0484 4055544 / 2349858 / 33555588
Fax : 0484 4055984
E-mail : cochin@schwingstetterindia.com

RAIPUR : House No. 108, Main Road Bhanpuri
Opposite Nine Block, Raipur 493221, Chattisgarh
Phone : 0771 2562325 Fax : 0771 2562465

MUMBAI : 620 / 621, Nirmal Lifestyle Corporate Centre,
6th floor, LBS Marg, Mulund(West), Mumbai 400 080.
Phone : 022 25624863 / 64, 30718300
Fax : 022 25624865 / 25624866
Email : mumbai@schwingstetterindia.com

BANGALORE : No 138-B, "UDAYAGIRI COMPLEX",
3rd Phase, KIADB Industrial area,
Peenya, Bangalore 560058,
Phone : 080 4243 8400, 080 33555588
Fax : 080 4243 8432, 080 30114301
Email : bangalore@schwingstetterindia.com

AHMEDABAD : 103, Shivalik Arcade,
Near Prahlad Nagar Auda Garden,
100 Ft. Anand Nagar Road, Satellite, Ahmedabad-380 051
Phone : 079 40244200, 079 3355 5588.
Fax : 079 40064084
Email : ahmedabad@schwingstetterindia.com

BHUBANESWAR : Plot No: 182, NH - 5,
Naharkanta, Rudrapur.PS: Baliana,
Beside Puri Main Canal, Bhubaneswar. Orissa - 752101.
Phone : 0674 2463999

GUWAHATI : House No - 124, Tripura Road,
Beltola, Guwahati - 781029. Assam.
Phone : 0361 2234738

NEW DELHI : 19, Okhla Industrial Estate,
Phase III, New Delhi - 110 020.
Phone : 011 42903000 / 30928500
Fax : 011 42903030 / 30928530
Email : newdelhi@schwingstetterindia.com

CHANDIGARH : SCO 165 , SECTOR 38 C&D,
Chandigarh (Union Territory) - 160 036
Phone : 0172 3957500 / 3957503 Fax : 0172 3957501
Email : chandigarh@schwingstetterindia.com

KOLKATA : CL 236, Salt Lake City, Sector II,
Near Karunamoyee Tank No.9, Kolkata - 700 091.
Phone : 033 2359 4320 / 330 / 33555588
Fax: 033 2359 4326
Email : kolkata@schwingstetterindia.com

PUNE : Arihant Court, Shop No. 1, 2 & 3, 481,
Rasta Peth, Next to Employment Exchange
Mudliar Road, Pune 411 011
Phone : 020 33555588 / 26055651 / 52
Fax : 020 2605 5653 / 30531517
Email : pune@schwingstetterindia.com

JAMSHEDPUR : D-27, 2nd Floor, Danish Apartment,
Masjid Road, Dhatkidih, Jamshedpur 831001
Phone : 9431328608 / 09709001441